

# ecowitt®

## CO<sub>2</sub> and Air Quality Monitoring

CO<sub>2</sub>(NDIR)/PM1.0/PM2.5/PM4.0/PM10/Temperature/Humidity  
7-in-1 AQI Sensor with LCD Screen



## Manual

Model WH46D



<https://s.ecowitt.com/F9VBJC>

## Contents

1. Ecowitt Ecosystem .....	1
2. Available Air Quality Sensors .....	3
3. Before Configuration .....	4
4. Getting Started .....	5
4.1. Parts List .....	5
4.2. Multiple Views and Size (Unit:mm) .....	6
4.3. Sensor Set Up .....	7
4.4. Display .....	9
4.5. Button .....	11
4.6. Icon and label .....	11
4.7. Adding and setting sensor on APP .....	13
5. Placement .....	14
6. View Online Data .....	15

7. History data on ecowitt.net .....	20
8. Sensor Placement & Mounting .....	22
9. Features .....	24
10. Specification .....	24
11. Carbon Dioxide(CO <sub>2</sub> ) Guidelines .....	27
12. Air Quality Index (AQI) Reference .....	28
13. What types of NDIR sensors exist and how do they work? .....	30
14. Troubleshooting for inaccurate readings .....	35
13.1 Auto Calibration Operation: .....	35
13.2 Mandatory Calibration: .....	36
15. CARE +MAINTENANCE .....	39
16. Warranty Information .....	42
17. FCC .....	43

18. After-sales Service .....	47
19. Stay in Touch .....	48

# 1. Ecowitt Ecosystem

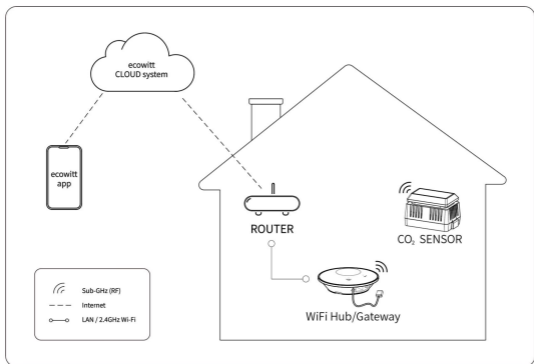

Welcome to our product! To send data to the ecowitt cloud server and enable users to access it via our mobile app, our product requires to be connected via a gateway and a router.

## **General Terms Used in the Manual:**

**Weather Station:** Includes the console and sensors (or sensor array).



**Gateway:** Also known as a hub, it is a Displayless console.

**Transmitter:** Refers to the sensor.

**Receiver:** Refers to the console.

**RF:** Radio frequency. It refers to the ISM and SRD SUBG (Industrial, Scientific and Medical and Short Range Devices frequency bands below 1 GHz) for communicating between the gateway and its sensors. This frequency is not the same as the 4G modem or Wi-Fi working frequency. ISM/SRD bands are kept separate from 4G frequencies by national regulations to avoid interferences. Typical ISM/SRD frequencies are 915 (Americas), 868 (Europe), 433 (worldwide), 920 (Japan, Korea).

## 2. Available Air Quality Sensors

Model	WH41	WH43	WH45	WH46	WH46D
Finish					
LCD Display					✓
CO <sub>2</sub>			✓	✓	✓
PM1.0				✓	✓
PM2.5	✓	✓	✓	✓	✓
PM4.0				✓	✓
PM10			✓	✓	✓
Temperature & Humidity			✓	✓	✓
Solar power supply	✓				
Power cord supply	✓	✓	✓	✓	✓
Battery backup	✓	✓	✓	✓	✓
Sensor ID Name	4 CH PM2.5		AQIN		

**Note:** If you have a WH41/WH43/WH45/WH46/WH46D PM2.5 sensor, the reading of PM2.5 may be different due to different sensor type used.

### 3. Before Configuration

Prepare a console that has been added to the Ecovitt app, ensuring the frequency matches. The compatible models are listed in the table below.

			
GW1XXX	GW2000	GW3000	WS38XX
			
WS39XX	WN182X	WN19XX	WN1980
			
WN1920	HP25XX	HP3500	WS6210

## **4. Getting Started**

### **4.1. Parts List**

One CO<sub>2</sub> and Air Quality Monitor

One USB Cable

One User Manual

## 4.2. Multiple Views and Size (Unit:mm)

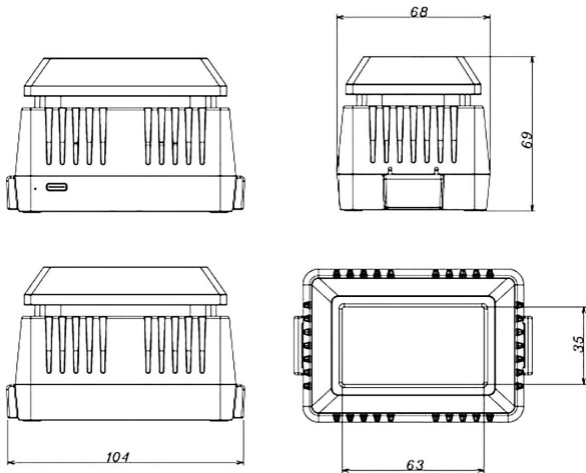

**Figure 1**

### 4.3. Sensor Set Up

1. Remove the battery door on the base of the air quality sensor as shown in **Figure 2**.

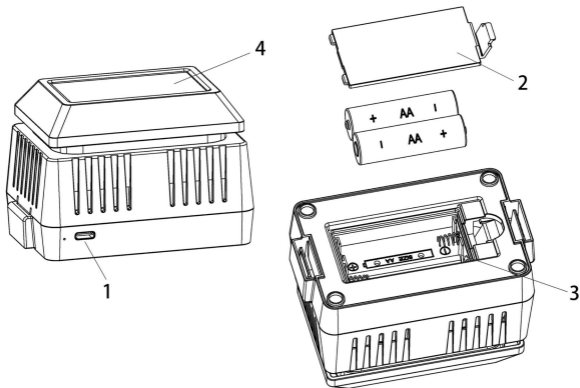

**Figure 2**

No	Description	No	Description
1	Type C port	2	Battery Compartment Cover
3	Battery Compartment	4	LCD Display

2.Insert two AA batteries and close the battery door.

**Note:** The batteries (not included) are mainly for backup purpose.

3.Connect the type-C cable between the sensor and an AC adapter(not included).

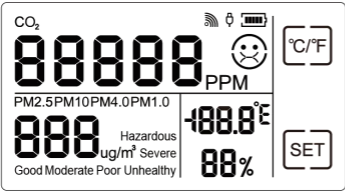
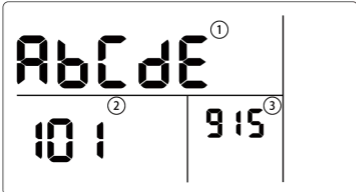

**Note:** After inserting the batteries or connecting AC power, the LCD layout segment will light.

## 4.4. Display



Content	Description
 <p>The main display screen shows the following information:</p> <ul style="list-style-type: none"> <li>CO<sub>2</sub> concentration: 88888 PPM</li> <li>PM2.5, PM10, PM4.0, and PM1.0 concentrations: 888 ug/m<sup>3</sup></li> <li>Temperature: 18.8 °C</li> <li>Humidity: 88%</li> <li>A smiley face icon indicating air quality.</li> <li>Buttons for °C/°F and SET.</li> </ul>	<p>Show all of content</p>
 <p>The secondary display screen shows the following information:</p> <ul style="list-style-type: none"> <li>Sensor ID: A b C d E (labeled ①)</li> <li>Firmware version: 101 (labeled ②)</li> <li>RF frequency: 915 (labeled ③)</li> </ul>	<p>① Sensor ID (The sensor ID consists of the letters A to E and the numbers 0 to 9.)</p> <p>② Firmware version</p> <p>③ RF frequency</p>



<p>CO<sub>2</sub> [Battery icon] [Sad face icon] °C/°F    [Five dashes] PPM    PM2.5 [Three dashes] °C    [Three dashes] ug/m<sup>3</sup> [Two dashes] %    SET</p>	<p>No data was read within 15 seconds, and it keeps showing “-”</p>
<p>CO<sub>2</sub> [Battery icon] [Happy face icon] °C/°F    436 PPM    PM10 35 ug/m<sup>3</sup> Good    27.2 °C    50%    SET</p>	<p>Done</p>

## 4.5. Button

Type	Description
	Press to switch temperature units °C or °F. Press to confirm the target readings while the CO2 calibration mode. (Learn more in <b>section 13</b> before calibration.)
	Press to switch PM2.5, PM10, PM4.0, PM1.0. Hold 5s to enter or exit the CO2 calibration mode. Press to add 10 PPM target readings per one while the CO2 calibration mode.

## 4.6. Icon and label

Type	Description
	RF signal
	DC power supply
	Battery status

	$0 < \text{PPM} < 800$
	$800 \leq \text{PPM} < 1200$
	$1200 \leq \text{PPM}$
“Good”	(The "PM_XX" including PM1.0, PM2.5 and PM4.0) $0 < \text{PM\_XX} \leq 12$ $0 < \text{PM}_{10} \leq 54$
“Moderate”	$12 < \text{PM\_XX} \leq 35.4$ $54 < \text{PM}_{10} \leq 154$
“Poor”	$35.4 < \text{PM\_XX} \leq 55.4$ $154 < \text{PM}_{10} \leq 254$
“Unhealthy”	$55.4 < \text{PM\_XX} \leq 150.4$ $254 < \text{PM}_{10} \leq 354$
“Severe”	$150.4 < \text{PM\_XX} \leq 250.4$ $354 < \text{PM}_{10} \leq 424$
“Hazardous”	$250.4 < \text{PM\_XX}$ $424 < \text{PM}_{10}$

## 4.7. Adding and setting sensor on APP

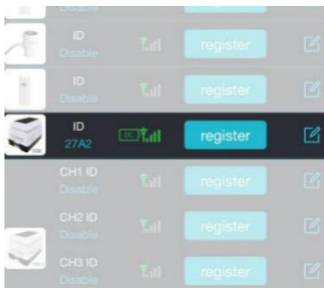

Open the ecowitt APP → “...” → “Sensor ID” → “”

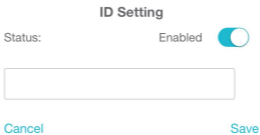

→Enter sensor ID (**section 4.4**) from WH46D to save

## 5. Placement



For long-term use, the sensor should be connected to a power supply, as battery power alone can only last for about 7 days. Therefore, battery power is used as a backup power source.

The particle sensor has a built in fan inside: It will be turned on/off regularly when measurement is needed. The fan noise will become more obvious during night quiet time. This noise is not possible to be eliminated and if you are sensitive to such noises, please do not use the device in your bedroom.

## 6. View Online Data

When paired with HP2550/HP2560 Console:

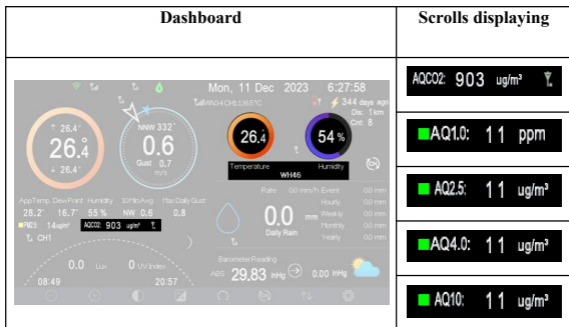

**Figure 1 Dashboard**

- The CO<sub>2</sub>, PM1.0, PM2.5, PM4.0, PM10 data automatically scrolls displaying on the screen every 5 seconds.

WH46		CH1	CH3
T&H 26.4 °C 54 %	CO2 903 ppm	24.8 °C --	25.6 °C --
PM2.5 9 ug/m <sup>3</sup> Good	PM10 10 ug/m <sup>3</sup> Good	Indoor 25.8 °C 56 %	Soil CH1 0 %
AQI 24H 41 41	AQI 24H 10 10		
PM1.0 8 ug/m <sup>3</sup> Good	PM4.0 10 ug/m <sup>3</sup> Good	Soil CH6 0 %	Soil CH7 24 %
AQI 24H 36 36	AQI 24H 43 43		
WN34 CH1	WN34 CH3	WN34 CH4	WN34 CH5
124.0 °C	24.9 °C	23.0 °C	26.3 °C

**Figure 2 Page Sensor Name&Data**

- The T&H, CO<sub>2</sub> , PM1.0, PM2.5, PM4.0, PM10 data on Figure 2 Page Sensor Name&Data  
**When paired with WS3800/WS39X0 Console:**

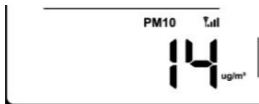
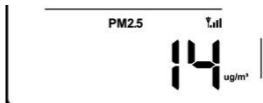
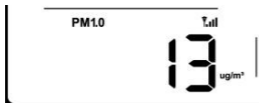

- Press button “+” to switch DATE, CO<sub>2</sub>, PM1.0, PM2.5, PM10 and AQI data when default mode.
- **Note:** The PM4.0 and Temp&Hum readings can be viewed on the Ecowitt APP, the inbuilt WebUI (<https://IP-address-of-console>) or on the dashboard at [ecowitt.net](https://ecowitt.net) (Ecowitt Weather Server), but will not be displayed on the WS3800/WS39X0 console

## When paired with other Console:

The readings can be viewed on the Ecowitt APP, the inbuilt WebUI (<https://IP-address-of-console>) or on the dashboard at [ecowitt.net](http://ecowitt.net).

## When uploaded data to Ecowitt APP:



- Edit panel and title by “...” .
- Tap “” to get graph of history data.

## When uploaded to Ecowitt Weather Server:



- View current sensor data & history records & graph on the website.
- Set and receive email alerts from the server when alarm condition set under your account.
- Remote monitoring with smart phone, laptop, or computer by visiting the website.

**Note:** On the 48-hour self-test which takes place with maximum fan rotation and is therefore clearly perceptible. You can set the commissioning start time by removing the batteries and the USB connection to a point in time where the necessary fan noise does not interfere.

## 7. History data on ecowitt.net



Export history data: ecowitt.net - click "Export" button on the dashboard.

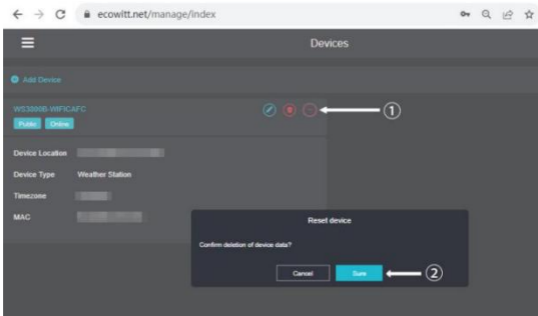

You can set the time period and data interval for the data here.

The data will be exported in .csv format.

Clear history data: Under "menu" → "devices" → "..."  
button to reset history data.

## 8. Sensor Placement & Mounting

Place the sensor on a horizontal surface. Make sure that the vents are clear of any obstructions, and we recommend placement away from other electronic devices to prevent interference. Do not place on a metal table to prevent RF signal loss.

**Note:** This sensor is designed for indoor use only. Wireless communication is susceptible to interference, distance, walls and metal barriers. We recommend the following best practices for trouble free wireless communication.

1. Electro-Magnetic Interference (EMI). Keep the console several feet away from computer monitors and TVs.
2. Radio Frequency Interference (RFI). If you have other devices using the same RF frequency and communication is intermittent, try turning off these other devices for troubleshooting purposes. You may need to relocate the transmitters or receivers to avoid intermittent communication.

3. Line of Sight Rating. This device is rated at 300 feet / 100 m line of sight (no interference, barriers or walls), but typically you will get a 100 feet maximum in most real-world installations, which includes passing through barriers or walls.
4. Metal Barriers. Radio frequency will not pass through metal barriers such as aluminum siding. If you have metal siding, align the remote and console through a window to get a clear line of sight.
5. Finally, please reset your sensor data on [ecowitt.net](http://ecowitt.net) and start using it.

**Note:** This device is mainly meant to detect the particle concentration in air. The accuracy for temperature and humidity reading may vary due to different environmental conditions: When the sensor is placed at unventilated environment, the temperature readings may be 2 degrees higher than the actual temperature.

When the sensor is placed at strongly ventilated environment, the temperature and humidity readings may be lower than the actually shown values.

## 9. Features

### CO<sub>2</sub> and Particulate Matter 1, 2.5, 4 and 10 sensor

- CO<sub>2</sub> photoacoustic NDIR sensors are usually more mechanically and thermally robust.
- It measures PM1.0, PM2.5, PM4.0, and PM10 every 60 seconds, whether powered with USB or batteries. It also measures CO<sub>2</sub> concentration. Temperature and Humidity every 30 seconds. The display is refreshed with each measurement.
- USB power Connection for indoor use only. This sensor has a display function, and you can view the data on the weather server after pairing it with our WiFi Gateway or Console (all sold separately).

## 10. Specification

Model	WH46D
Name	CO <sub>2</sub> and Air Quality Monitor
Dimensions	106×68×67(mm)
Screen Size	63×35(mm)
Material of Screen	HTN
Material of Plastic Casing	ABS

Weight	144(g)
Material of Plastic Casing	ABS
Mass concentration range	0 ug/m <sup>3</sup> to 1000 ug/m <sup>3</sup>
Mass concentration precision for PM1.0 & PM2.5	± <b>【5ug/m<sup>3</sup>+5%】</b> (0 ug/m <sup>3</sup> to 100 ug/m <sup>3</sup> ) ±10 % (100 ug/m <sup>3</sup> to 1000 ug/m <sup>3</sup> )
Mass concentration precision for PM4.0 & PM10	±25 ug/m <sup>3</sup> (0 ug/m <sup>3</sup> to 100 ug/m <sup>3</sup> ) ±25 % (100 ug/m <sup>3</sup> to 1000 ug/m <sup>3</sup> )
Mass concentration resolution	1 ug/m <sup>3</sup>
CO <sub>2</sub> measuring range	0 to 40000 ppm
CO <sub>2</sub> measurement accuracy	±(50 ppm + 5% of reading) when 400 to 2000 ppm
CO <sub>2</sub> Accuracy drift per year	± (5ppm + 5% of reading)
CO <sub>2</sub> measurement resolution	1 ppm
Temperature Metering Range	-10°C to 60°C (14°F to 140°F)
Temperature Metering Accuracy	±0.8°C (1.5°F) when 15°C to 35°C (59°F to 95°F) ±1.5°C (2.7°F) when -10°C to 60°C (14°F to 140°F)

Temperature Metering Resolution	0.1°C ( 0.1°F)
Humidity Metering Range	1%RH to 99%RH
Humidity Metering Accuracy	± 6%RH when 15°C to 35°C (59°F to 95°F) ± 9%RH when -10°C to 60°C (14°F to 140°F)
Humidity Metering Resolution	1%RH
Humidity Accuracy drift per year	< 0.25%RH
Automatic cleanup interval	2 days
Reading Update Interval	About 1 minute
RF Connection Frequency	920/915/868/433MHz (depending on local regulations)
RF Wireless Range	Over 100 meters (in open areas)
Operating Temperature Range	-10°C to 50°C(14°F to 122°F)
Power Supply	2*1.5AA or USB 5V
Battery Life	7 days

## 11. Carbon Dioxide(CO<sub>2</sub>) Guidelines

CO<sub>2</sub> levels are a primary indicator of indoor air freshness and ventilation efficiency. Use the following guide to interpret your indoor CO<sub>2</sub> readings:

- 250-350 ppm: background (normal) outdoor air level.
- 350-1,000 ppm: typical level found in occupied spaces with good air exchange.
- 1,000-2,000 ppm: level associated with complaints of drowsiness and poor air.
- 2,000-5,000 ppm: level associated with headaches, sleepiness, and stagnant, stale, stuffy air; poor concentration, loss of attention, increased heart rate and slight nausea may also be present.
- >5,000 ppm: This indicates unusual air conditions where high levels of other gases also could be present. Toxicity or oxygen deprivation could occur. This is the permissible exposure limit for daily workplace exposures.
- >40,000 ppm: This level is immediately harmful due to oxygen deprivation.

## 12. Air Quality Index (AQI) Reference

This section provides the concentration breakpoints for PM<sub>2.5</sub> and PM<sub>10</sub> particles. These standards are used to calculate the Air Quality Index (AQI) shown on your device.

AQI Index	Category	PM <sub>2.5</sub> (µg/m <sup>3</sup> )	PM <sub>10</sub> (µg/m <sup>3</sup> )	Health Implications
<b>0 - 50</b>	<b>Good</b>	<b>0 – 35</b>	<b>0 – 50</b>	<b>Air quality is satisfactory; no health risk<sup>3</sup>.</b>
<b>51 - 100</b>	<b>Moderate</b>	<b>35.1 – 75</b>	<b>51 – 150</b>	<b>Acceptable quality; sensitive individuals should limit exertion<sup>4</sup>.</b>
<b>101 - 150</b>	<b>Lightly Polluted</b>	<b>75.1 – 115</b>	<b>151 – 250</b>	<b>Slight irritation may occur; sensitive groups should stay indoors<sup>5</sup>.</b>
<b>151 - 200</b>	<b>Moderately Polluted</b>	<b>115.1 – 150</b>	<b>251 – 350</b>	<b>Health effects likely for the</b>

AQI Index	Category	PM2.5 (µg/m3)	PM10 (µg/m3)	Health Implications
				<b>public; avoid long outdoor exposure<sup>6</sup>.</b>
<b>201 - 300</b>	<b>Heavily Polluted</b>	<b>150.1 – 250</b>	<b>351 – 420</b>	<b>High health risk; heart/lung patients should remain indoors<sup>7</sup>.</b>
<b>&gt; 300</b>	<b>Severely Polluted</b>	<b>&gt; 250</b>	<b>&gt; 420</b>	<b>Emergency conditions; everyone should avoid outdoor activity<sup>8</sup>.</b>

Note:

1. The WH46D sensor data can be only viewed on the Live Data interface since it doesn't support uploads to weather underground.

2. If you choose to upload the data to our weather server: <https://www.ecowitt.net>, you can view the live

data/history graph and download the records on the website. You can add a shortcut of the website on the home screen of your phone for quick access.

### **13. What types of NDIR sensors exist and how do they work?**

An introduction to the principles behind transmissive and photoacoustic NDIR sensing

Characteristics of NDIR Sensors:

NDIR sensing has become the prevalent technique for measuring CO<sub>2</sub> concentration. The technology exploits the characteristic property of CO<sub>2</sub> molecules to strongly absorb infra-red (IR) light with wavelengths around 4.2 μm. When shining light of this wavelength through a gas sample, the CO<sub>2</sub> concentration can thus be calculated from the proportion of light that is absorbed. It is important to note that NDIR sensors do not require a dispersive element, such as a prism or a diffraction grating, to discriminate for the targeted wavelength. Instead, the light produced by the emitter is shown through a non-dispersive band-pass filter, allowing

only the infrared wavelengths of interest to pass. These characteristics give the sensors their classification:  
Non-dispersive Infra-red.

Transmissive NDIR:

These NDIR sensors typically feature an IR emitter and an optical detector, such as a photodiode, at opposite ends of a specially designed optical cavity. The optical detector measures the amount of IR light energy that is not absorbed by (i.e., transmitted through) the gas sample.

As the CO<sub>2</sub> concentration in the optical cavity increases, the amount of light detected decreases. Hence, this principle determines the amount of light energy CO<sub>2</sub> molecules have absorbed by calculating the difference between the measurement and a reference intensity at a known CO<sub>2</sub> concentration.

**NDIR CO<sub>2</sub> sensors leverage infra-red absorption at 4.2 μm wavelength without the**

## use of dispersive optical elements.

Absorption spectra of common trace gases

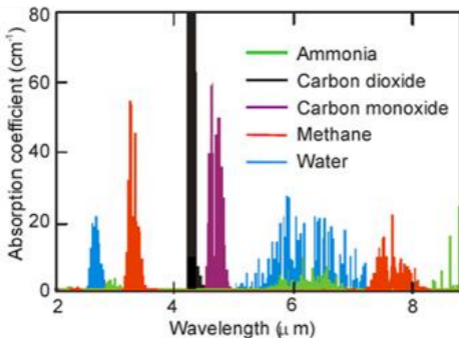

(HITRAN2016 molecular spectroscopic database)

Note that this reference value heavily depends on precise positioning of IR emitter and photodetector, as well as the emission properties of the IR source and the

optical cavity. Mechanical and thermal stresses acting on the measurement chamber can thus significantly falsify CO<sub>2</sub> readings.

Furthermore, transmissive NDIR sensors generally require a minimal optical path length in the centimeter scale for enough IR absorption to occur to accurately measure lower CO<sub>2</sub> concentrations.

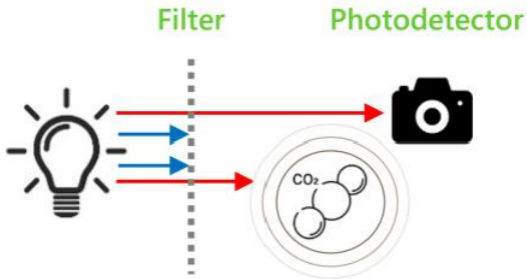

## Photoacoustic NDIR:

In contrast to transmissive NDIR sensors, photoacoustic NDIR sensors detect the amount of energy that is absorbed by CO<sub>2</sub> molecules. When pulsing the infra-red emitter, CO<sub>2</sub> molecules absorb infra-red light periodically. This causes additional molecular vibration resulting in a pressure wave inside the measurement chamber. The higher the CO<sub>2</sub> concentration, the more light is absorbed, and thus the greater the amplitude of this acoustic wave becomes.

A microphone inside the gas chamber measures this, from which the CO<sub>2</sub> concentration can then be calculated.

Photoacoustic NDIR sensing allows for much greater miniaturization of the measurement chamber. Furthermore, as sound waves are omnidirectional, relative positioning of emitter and microphone is

unconstrained. Thus, photoacoustic NDIR sensors are usually more mechanically and thermally robust.

## **14. Troubleshooting for inaccurate readings**

### **13.1 Auto Calibration Operation:**

If you find that the readings of the carbon dioxide sensor are inaccurate after a period of use, please place the device in a well-ventilated location for at least one day. Make sure there are no other sources of pollution around, and ensure that the sensor surface is not obstructed or affected by external interference. It is important to keep the device connected to the power

supply and in normal working condition without shutting down or interrupting the power supply. By continuously detecting the carbon dioxide concentration in the environment, the sensor will automatically calibrate its readings.

### **13.2 Mandatory Calibration:**

Place the sensor outdoors, exposing it to outside air for 30 minutes. If the CO<sub>2</sub> level displayed is not 350~500ppm range, you can activate the calibration mode by pressing the "SETUP" button for 5s. The current PPM reading and 400 target reading digits will be flashing. You can press the "SET" button to choose between 400~420ppm, and then press "°C/°F" to continue, leaving the device untouched for 5 minutes until the calibration routine is completed and returns to normal display mode. You can always return to this calibration mode if you have doubts about the accuracy.



**Figure 3 Calibration Setup**

If calibration is triggered by mistake, hold “SET” to cancel and exit. The target readings enable to set 400 to 1990.



## Figure 4 Calibrating

After calibration, the screen will automatically return to the standard screen. Otherwise, the animation will be spinning to check the environment until the CO<sub>2</sub> stabilizes.



**Figure 5 Loading**

Please don't do anything when it is loading the calibration value.

## **15. CARE + MAINTENANCE**

When batteries of different brand or type are used together, or new and old batteries are used together,

some batteries may be over-discharged due to a difference of voltage or capacity. This can result in venting, leakage, and rupture and may cause personal injury.

- Do not mix Alkaline, Lithium, standard, or rechargeable batteries.
- Always purchase the correct size and grade of battery most suitable for the intended use.
- Always replace the whole set of batteries at one time, taking care not to mix old and new ones, or batteries of different types.
- Clean the battery contacts and also those of the device prior to battery installation.
- Ensure the batteries are installed correctly with regard to polarity (+ and -).
- Remove batteries from product during periods of non-use. Battery leakage can cause corrosion and damage to this product.

- Remove used batteries promptly.
- For recycling and disposal of batteries, and to protect the environment, please check the internet or your local phone directory for local recycling centers and/or follow local government regulations.

**Manufacture: ShenZhenShi OuSaiTeDianZi YouXianGongSi**  
**Address: Shajingjiedao, Xihuanlu, Minzhujiujiugongyecheng AQu,**  
**C Dong 4 Ceng A, Shenzhen Baoanqu Guangdong 518101 CN**

## **16. Warranty Information**

**We disclaim any responsibility for any technical error or printing error, or the consequences thereof. All trademarks and patents are recognized.**

We provide a 1-year limited warranty on this product against manufacturing defects, or defects in materials and workmanship.

This limited warranty begins on the original date of purchase, is valid only on products purchased, and only to the original purchaser of this product. To receive warranty service, the purchaser must contact us for problem determination and service procedures.

This limited warranty covers only actual defects within the product itself and does not cover the cost of installation or removal from a fixed installation, normal set-up or adjustments, or claims based on misrepresentation by the seller, or performance variations resulting from installation-related circumstances.

## 17. FCC

This device complies with part 15 of the FCC Rules. Operation is subject to the condition that this device does not cause harmful interference (1) this device may not cause harmful interference, and (2) this device must accept any interference received, including interference that may cause undesired operation.

Changes or modifications not expressly approved by the party responsible for compliance

could void the user's authority to operate the equipment.

**NOTE:** This equipment has been tested and found to comply with the limits for a Class B digital device, pursuant to Part 15 of the FCC Rules. These limits are designed to provide reasonable protection against harmful interference in a residential installation. This equipment generates, uses and can radiate radio frequency energy and, if not installed and used in accordance with the instructions, may cause harmful

interference to radio communications. However, there is no guarantee that interference will not occur in a particular installation.

If this equipment does cause harmful interference to radio or television reception,

which can be determined by turning the equipment off and on, the user is encouraged to try to correct the interference by one or more of the following measures:

- Reorient or relocate the receiving antenna.
- Increase the separation between the equipment and receiver.
- Connect the equipment into an outlet on a circuit different from that to which the receiver is connected.
- Consult the dealer or an experienced radio/TV technician for help.

To maintain compliance with RF Exposure guidelines, This equipment should be installed and operated with minimum distance between 20cm the radiator your body: Use only the supplied antenna.

IC Caution:

English:

This device contains licence-exempt transmitter(s) /receiver(s) that comply with Innovation, Science and Economic Development Canada's licence-exempt RSS(s). Operation is subject to the following two conditions:

1. This device may not cause interference.
2. This device must accept any interference, including interference that may cause undesired operation of the device.

French:

L'émetteur/récepteur exempt de licence contenu dans le présent appareil est conforme aux CNR d'Innovation, Sciences et Développement économique Canada applicables aux appareils radio exempts de licence.

L'exploitation est autorisée aux deux conditions suivantes :

1. L'appareil ne doit pas produire de brouillage;
2. L'appareil doit accepter tout brouillage radioélectrique subi, même si le brouillage est susceptible d'en compromettre le fonctionnement.

## **18. After-sales Service**

### **Order Issues:**

If you encounter any missing or incorrect shipments of Ecowitt products purchased, please reach out to the respective platform's customer service from the store you bought product for assistance.

### **Usage Inquiries:**

For any issues related to product usage, feel free to contact our customer support team at [support@ecowitt.com](mailto:support@ecowitt.com). We are committed to providing assistance and resolving any concerns you may have.

## 19. Stay in Touch

Ask questions, watch setup videos, and provide feedback on our social media outlets. Follow Ecowitt on Discord, YouTube, Facebook and Twitter.



Copyright©2026 ecowitt All Rights Reserved. DC020626